

DGH10J-01P-1Y-01A(H)

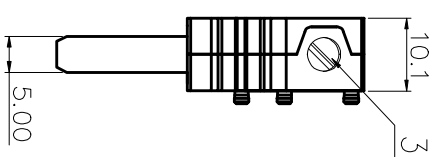

精度等级/General	tolerance(mm)	0	>3	>6	>10	>18	>30	>50	>80	>120	>180	>250	>315	>400	>500	0.1/1/10
~	~	~	~	~	~	~	~	~	~	~	~	~	~	~	~	±Z
±0.12	±0.18	±0.22	±0.26	±0.31	±0.37	±0.40	±0.46	±0.53	±0.60	±0.68	±0.76	±0.85	±0.93	±1.05	±1.15	±1.60 ±2.20 ±2.50

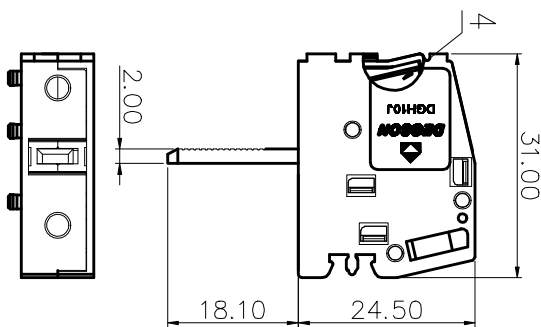
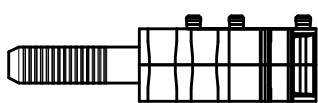
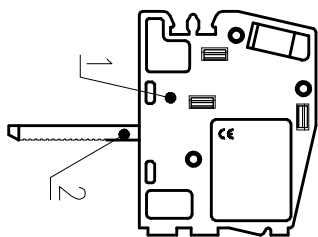
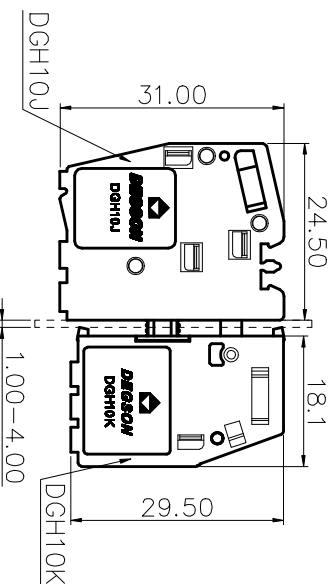

DGH10K-01P-1Y-00A(H)

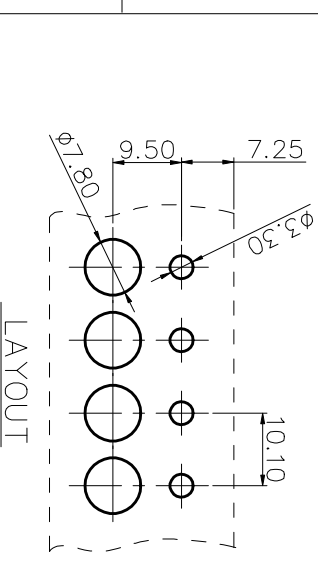
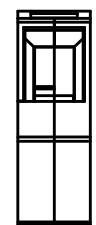
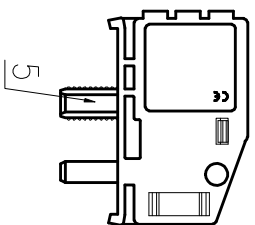
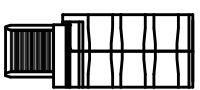
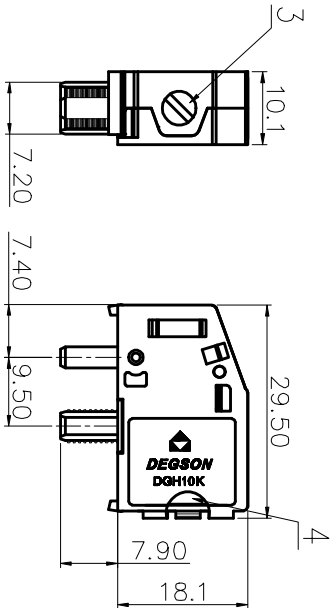

UL 标准/UL Standard:	B	C	D
额定电压/电涌/Rated Voltage(V)/Current(A)	300/65	/	300/70
EC 标准/IEC Standard:			
过压类别/Overvoltage Category/污染等级/Pollution Degree	III/3	III/2	II/2
额定电压/电涌/Rated Voltage(V)/Current(A)	500/76	/	/
额定冲击电压(kV)/Rate Impulse Voltage(kV)	8	/	/
扭矩范围(螺栓和螺线)/Wire Range(rigid and flexible)(mm ² /AWG)	0.5~1.6/24~6		
间距/Pitch(mm)/线数范围/Poles	10.1/01P		
剥线长度/Stripping length(mm)	10		
使用温度范围/Operating temperature(°C)	-40~+105		
符合RoHS环保要求/Conform to RoHS	Yes		

ITEM	NAME OF PART	MATERIAL	NOTES
5	Housing-K	PA66	UL94V-0
4	Cage	Copper alloy	M4/Ni Plated
3	Screw	Steel	M4/Zn Plated
2	Current Carrier	Copper	Sn Plated
1	Housing-J	PA66	UL94V-0

REV	ECN	DESCRIPTION	DRAFT	DATE

MATERIAL: /	SURFACE: /
MAT NO.: /	
STATUS: /	
APPD: /	
CHKD: /	
DRAFT: Apple 2015.01.06	DRAWING NO.: DGH10-C01
SIZE: A4	TYPE: CUSTOMER DRAWING
SCALE: 2:1	SHEET 1/1

DEGSON® NINGBO DEGSON ELECTRICAL CO., LTD
 宁波高松电子有限公司

DGH10-01P-1Y-00A(H)